



# INLINE EXTRACTION FAN KITS without Lights

These kits are designed so that the interior grille can be mounted directly above your steam source (e.g. shower or bath). Kits with the low profile fascia are supplied with a choice of stylish grilles. Mixed flow fans provide users with a two fan speed option. 5 year warranty.

Pro-Series Low Profile	Duct (mm)	Fan Type	Max. Fan Watts (W)	Max. Fan Pressure (PA)	Free Air Fan Performance		Specific Fan Power (W/l/s)	Interior Grille	Exterior Grille	Switching	Model	Order Code
					(l/s)	(m <sup>3</sup> /hr)						
	150	Mixed Flow	70 60	300 240	166 92	597 330	0.42 0.65	Round White	Round White	Standard	MFLP150S	FAN2051
	125	Mixed Flow	40 26	220 160	89 72	320 260	0.45 0.36	Round White	Round White	Standard	MFLP125S	FAN2050
	100	Mixed Flow	40 26	180 120	69 53	250 190	0.58 0.34	Round White	Round White	Standard	MFLP100S	FAN2049
	150	Axial	18	91	105	380	0.17	Round White and Square White	Weatherproof Cowl White and Fixed Louvre White	Standard	SFLP150S	FAN0618
									Weatherproof Cowl White and Fixed Louvre White	Timer	SFLP150T	FAN0619
	125	Mixed Flow	40 26	220 160	89 72	320 260	0.45 0.36	Round White and Square White	Weatherproof Cowl White and Fixed Louvre White	Standard	SFLP125S	FAN0616
									Weatherproof Cowl White and Fixed Louvre White	Timer	SFLP125T	FAN0617
Classic Standard Profile	Duct (mm)	Fan Type	Max. Fan Watts (W)	Max. Fan Pressure (Pa)	Free Air Fan Performance		Specific Fan Power (W/l/s)	Interior Grille	Exterior Grille	Switching	Model	Order Code
		(l/s)	(m <sup>3</sup> /hr)									
	150	Axial	18	91	105	380	0.17	Round White	Fixed Louvre White	Standard	SF150S	FAN0101
										Timer	SF150T	FAN0102
	125	Axial	20	35	42	153	0.48	Round White	Fixed Louvre White	Standard	SF125S	FAN0064
										Timer	SF125T	FAN0065
	100	Centrifugal	20	120	31	110	0.65	Round White	Fixed Louvre White	Standard	SF200S	FAN0328
										Timer	SF200T	FAN0329
		Axial	24	24	23	85	1.04	Round White	Fixed Louvre White	Standard	SF100S	FAN0017
										Timer	SF100T	FAN0018

**Note:** Installed system performance is always influenced by duct length and layout

## Switching Options

**Standard** Remote switch (not supplied).

**Timer** Remote switch (not supplied). Fan continues operating for preset time after switching off.

# INLINE EXTRACTION FAN KITS without Lights

## Dimensions (mm)

Model	Grille Cut-Out	A	B	C	D	E	F	G
MFLP150	160	209	147	360	55	195	115	130
MFLP125	140	182	122	350	60	168	100	100
MFLP100	115	182	98	315	27	168	100	100
SFLP150	160	200	143	170	185	-	-	-
SFLP125	140	182	122	350	60	168	100	100
SF150	160	200	143	170	185	-	-	-
SF125	140	155	150	99	118	27	-	-
SF200	115	100	155	100	195	258	-	-
SF100	115	155	130	90	100	27	-	-

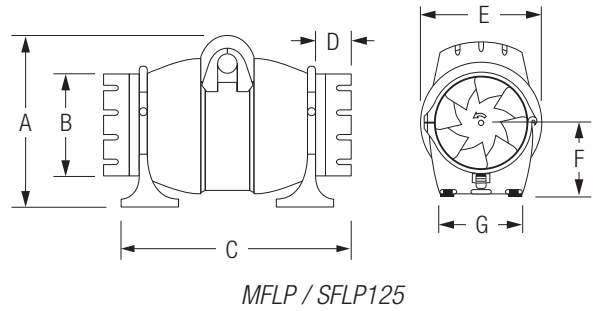

MFLP / SFLP125

**Note:** Grille cut-out size is a nominal diameter for a circular cut-out.

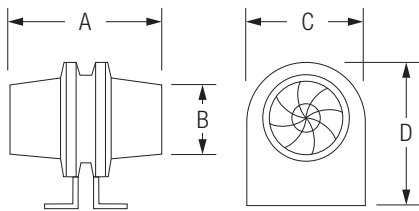

SFLP150  
SF150

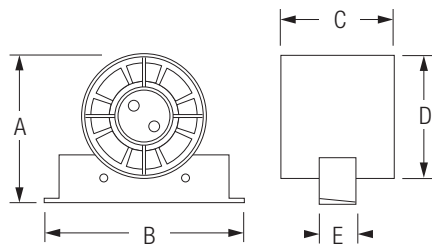

SF125 / SF100

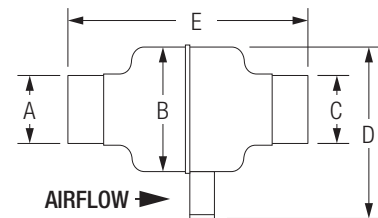

SF200

## Technical

Model	MFLP150	MFLP125	MFLP100	SFLP150	SFLP125	SF150	SF125	SF200	SF100
Supply	220-240V AC, 50Hz								
Sound Level	47 dB(A)	43 dB(A)	40 dB(A)	38 dB(A)	43 dB(A)	38 dB(A)	41 dB(A)	45 dB(A)	41 dB(A)
Max. Operating Temp	60°C	45°C	45°C	45°C	45°C	45°C	50°C	50°C	50°C
IP Rating	IPX4	IPX4	IPX4	IP44	IPX4	IP44	IPX4	IPX4	IPX4
Duct	6m Unilok Nude			5m Flexible PVC	4m Flexible PVC	5m Flexible PVC	4m Flexible PVC	3m Flexible PVC	

